



BIKE-PACK SYSTEM™

Thank you for purchasing our VENTURA BIKE-PACK SYSTEM.
Before use please read all instructions and our Limited Warranty carefully.

To Fit: Honda CB 400 Four

H009/S L-Bracket
PF11/S Pack-Rack. For use with 'Aerodynamic' system packs.
SR11/S Sport-Rack

A range of various style packs for the 'Aerodynamic' systems, along with storm covers and optional shoulder straps (where applicable) are available.

Check with your local dealer, distributor or contact us direct for the latest models.

FITTING KIT CONTENTS

LD001/S locking device (fitted to L-Brackets)

1 LK001/S Key

Where additional instructions are supplied they should be read in conjunction with the General Fitting Instructions below:

GENERAL FITTING INSTRUCTIONS

The following General Fitting Instruction should be used as a guide where there are no additional special instructions supplied.

The L-Brackets fit either side of and below rear of seat. It is important that the tops of the L-Brackets, where the Pack-Rack and Sport-Rack fit, are parallel in a vertical plane when looking from the rear of the bike. If adjustment is needed, use the Pack-Rack or Sport-Rack as shown in diagram, and gently apply pressure up or down as necessary until parallel.

- 1 Fit Pack-Rack or Sport-Rack into the L-Brackets, ensure the rack is level and tighten all the mounting bolts.
- 2 Tighten the L-Bracket locking devices by following the procedure in the General Instructions For Use.

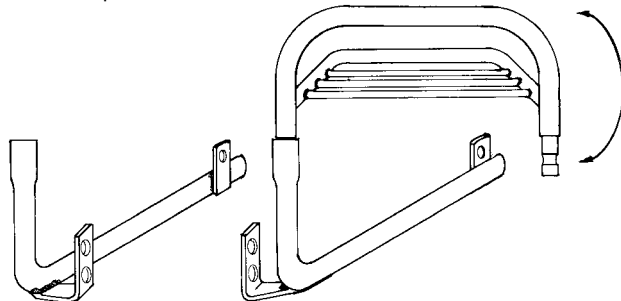

GENERAL INSTRUCTIONS FOR USE



The following instructions should be strictly adhered to. Failure to do so may result in an accident causing injury or death.

Locking Device Tightening Instruction

For racks with formed indents on swaged ends.

- 1 Ensure the knurled locking nut is wound fully back and is in contact with the head of the locking device.
- 2 Tighten the locking device firmly and securely by hand making sure that it is centrally located in the indented groove on the swaged legs of the rack.
- 3 Turning the knurled locknut clockwise, tighten firmly by hand. Using the key tighten an extra 2mm ($\frac{1}{8}$ " approx) of circumference travel.

For racks without indents

- 1 Ensure the knurled locking nut is wound fully back and is in contact with the head of the locking device.
- 2 Tighten the locking device by hand until it comes into positive and firm contact with the rack.
- 3 Using the key, tighten a further 1.125 ($1\frac{1}{8}$) turns.
- 4 Turning the knurled locknut clockwise, tighten firmly by hand. Using the key tighten an extra 2mm ($\frac{1}{8}$ " approx) of circumference travel.

BEFORE USE

All fasteners and components must be checked for tightness and security before each ride.

RIDING SOLO

When riding solo always have the pack facing forward with the load over the pillion seat.

RIDING WITH A PILLION PASSENGER

When riding with a pillion passenger the pack must be fitted facing rearwards.

RECOMMENDATION

Any surfaces that could possibly come in contact with the pack(s) should be covered with protective material such as abrasion resistant film, to prevent marking or damage to the surface finish.

SECURING PACK TO PACK-RACK

To secure the pack use the straps with the quick release clips and attach around the horizontal rung on the Pack-Rack carrier. On some models the quick release system is not available. In this situation loop the shoulder straps around the rung and fasten to the buckle.

WARNING - The VENTURA Bike-Pack System was not designed as a back rest and should not be used as one by the pillion passenger.

PACKING THE PACK

Always place heavy items at the bottom of the pack and load evenly. Do not position sharp objects against the fabric of the pack.

MAXIMUM CARRYING CAPACITY

Unless specified to the contrary in the fitting instructions or the motorcycle manufacturers recommendations/specifications the recommended maximum load capacity of this system is 9kg (20lbs). It is important that the pack is always securely fastened to the Pack-Rack.

MAXIMUM SPEED

The maximum recommended speed that this system can be used is 130 kph (80mph) or the legal speed limit, whichever is the lower. This limit may be reduced by other accessories, worn tyres, improper handling, overall motorcycle condition or weather conditions.

REMEMBER

Exceeding the weight capacity or the recommended maximum speed may drastically affect the motorcycles handling, stability and performance.

L-BRACKETS

The L-Brackets must always have the Pack-Rack, Sport-Rack or Grab-Handle fitted.

IMPORTANT

The **VENTURA BIKE-PACK SYSTEM** is designed as a complete unit. The use of non **VENTURA** parts, bags or other attachments will render the warranty void.

"Happy and Safe Motorcycling"

LIMITED WARRANTY

NOTE: Some jurisdictions do not allow limitations on how long an implied warranty, if any, lasts, and do not allow the exclusion of limitation of incidental or consequential damages so the limitations and exclusions below may not apply to you. This warranty gives specific legal rights, you may have other rights which vary from jurisdiction to jurisdiction.

Dold Industries Limited ("Dold") warrants this product to be free from defects in materials and workmanship under normal use and maintenance for a period of one year from its date of original purchase. Dold shall, at its option, either repair or replace a defective product returned to it or its authorised agents, freight prepaid.

This warranty does not apply to any product which has been altered, damaged or rendered non-functional through improper installation or maintenance, abnormal wear and tear due to exposure to the elements, negligence, abuse, accidents or any like circumstance.

Dold shall not be liable for any incidental nor consequential loss or damage resulting directly or indirectly from any defective product, its sole obligation being to repair or replace such defective product.

This warranty is in lieu of, and excludes, all other warranties, expressed or implied, including the warranties of merchantability and of fitness for a particular purpose.

To make a warranty claim return the product to the dealer who supplied it with evidence of date of purchase. If you are not satisfied with their response, please contact the distributors for your country or: Dold Industries Ltd, 17 Perclo Place, P O Box 10-393, Te Rapa, Hamilton, New Zealand. Telephone +64 (7) 849-4392. Facsimile +64 (7) 849-4114. E-mail: dold@ventura-bike.com Internet: www.ventura-bike.com

E & O E